

A14 Series full glass entrance doors

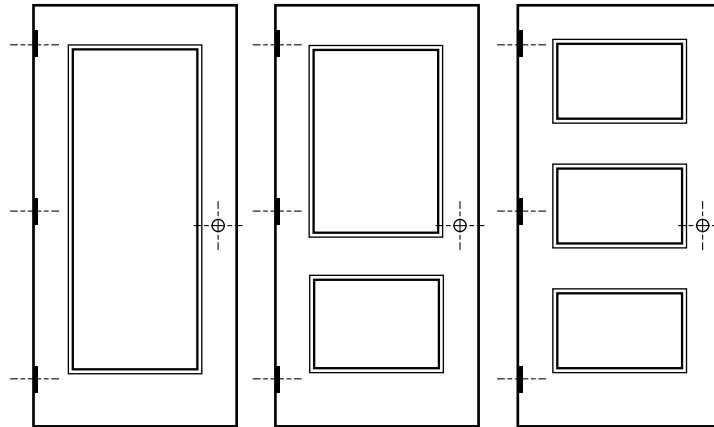

About the product

The A14 Series full glass entrance doors are designed to meet the architectural requirements for exterior entrance applications. Refer to Section 11 (Architectural) for specifications and the selection and usage guide of the appropriate door constructions.

A14 Series doors are available for high frequency openings and entrances where large full glass (FG, FG2, and FG3) lights are required. This premium door construction combines the strength and dimensional stability of steel with the structural integrity of the laminate core with internal corner gussets to provide added strength and rigidity.

To meet application, specification and performance requirements for entrance door applications, the A14 Series Door offers a wide range of specifiable options including sizes, glass light designs and hardware (mechanical, pneumatic, electrical) preparations.

A14 Series doors are 1 3/4" (45 mm) thick.

Installation

1. Installation shall conform to the published Steelcraft installation instructions, ANSI A250.11-2012 (formerly SDI 105) *Recommended Erection Instructions for Steel Frames and HMMA 840*.
2. Fire Rated Assemblies must be in accordance with NFPA Pamphlet 80. The *Authority Having Jurisdiction* is the final authority in issues related to the installation and use of installed Fire Rated Doors.

Features and benefits

Steelcraft's A14 Series doors offer the following standard unique features, which enhance long term performance and durability:

1. **Honeycomb Core Systems** that enhance the structural integrity of the door:
 - 1" (25 mm) cell kraft honeycomb configuration with internal corner gussets to provide added strength and rigidity.
2. **Seamless edges** with full height, epoxy filled mechanical Interlock edges, provide structural support and stability the full height of the door. Edges are seam filled with structural adhesive and dressed smooth. Includes tack welds above and below edge cutouts for hinges, locks, etc.
3. **Universal Hinge Preparations** (patented) allow for easy field conversion from standard weight .134" (3.3 mm) hinges to heavy weight .180" (4.7 mm) hinges.
4. **14 Gauge [0.067" (1.7 mm)] Inverted Top and Bottom Channels** provide stability and protection for the top and bottom edges from abuse.
5. **Beveled Hinge and Lock Edges** allow for tighter installation tolerances, ensure easier operation and eliminate binding and sticking.
6. **Recessed Dezigner™ Glass Trim** provides a clean, neat and flush finish with the door surface.
7. **Factory Applied Baked-On Rust Inhibiting Primer** paint in accordance with ANSI A250.10-2011.

Specification compliance

1. Door construction for Steelcraft A14 Series doors meets the requirements of ANSI A250.8-2014 (SDI 100).
2. Hardware preparations and reinforcements are in accordance with ANSI A250.6-2003 (R2009). Locations are in accordance with ANSI/DHI A115 unless otherwise stated.

Fire ratings

A14 Series doors meet fire rating requirements. They are listed for installations requiring compliance to NFPA252-1999 and UL-10C.

Standard Laminated Honeycomb Core with internal corner gussets

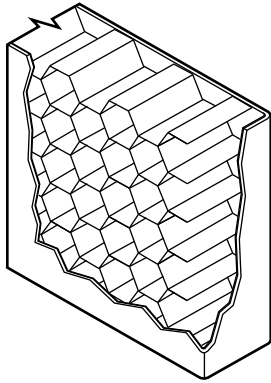

- 1" (25 mm) cell, 99 pound Kraft honeycomb
- Honeycomb surfaces sanded for maximum adhesion
- Impregnated with phenolic resin (resists mildew and vermin)
- Laminated to both face sheets with contact adhesive
- Assembled door is run through high pressure pinch rollers, achieving ultimate bond

Standard Premium Edge Construction

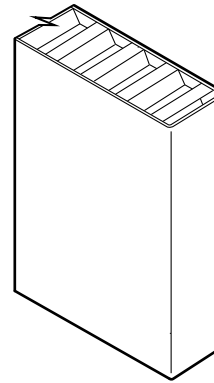

- Beveled hinge & lock edges
- Full height mechanical Interlock with structural adhesive
- Tack welds above and below edge cutouts for hinges, locks, etc.
- Edge Seam filled with structural adhesive and dressed smooth
- No visible edge seam

Standard Rigid 14 Gauge End Channel Construction

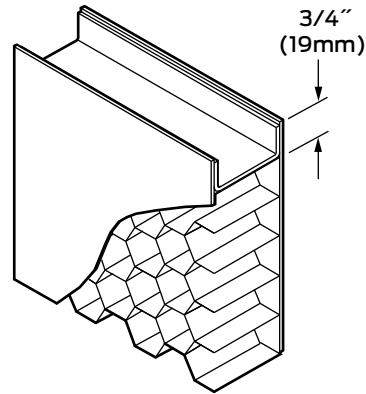

- 14 gauge inverted galvanized top & bottom channels
- Projection welded to both face sheets
- For optional caps, see ["Weather seals" on page 145.](#)

Door application and usage			
Series	Steel Thickness	Opening	Usage Frequency
A14	14 Ga (1.7 mm)	Interior: Cold Rolled Steel	Maximum Duty
A14	14 Ga (1.7 mm)	Exterior: Galvanized Steel	Extra Heavy Commercial applications with potential of very high use

Standard hardware preparations

Typical hardware applications shown. Refer to "Hardware" section for more details.

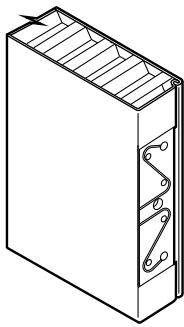

Universal Mortise Hinge Prep
7 Gauge Universal hinge reinforcement

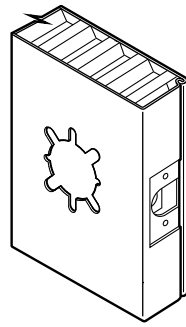

61L Lock

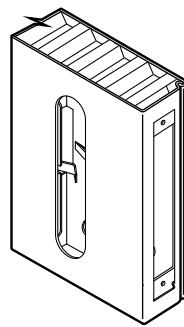

86 Lock

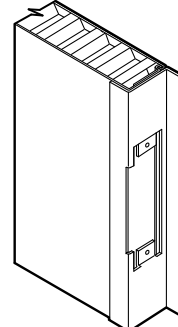

Inactive Leaf ASA Strike Prep with Astragal attached

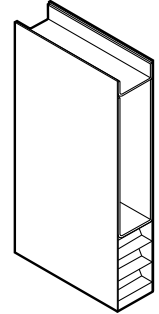

14 Gauge Closer Reinforcement

Standard: mortised and reinforced for

- Patented Universal hinge preparations allow for easy field conversion from standard 4 1/2" (114 mm) x .134" (3.3 mm) standard weight hinges to 4 1/2" (114 mm) x .180" (4.7 mm) heavy weight hinges. Optional hinge preparation for 5" (127 mm) x .146" (3.7 mm) standard weight hinges or for 5" (127 mm) x .190" (4.8 mm) heavy weight hinges is also available.
- A multitude of standard lock preparations are available. The cylindrical 161, 61L and mortise 86 lock preps are the most commonly used active leaf preparations. The 4 7/8" (124 mm) strike prep is the most commonly used inactive leaf preparation.
- Optional reinforcements for surface and concealed Closers are available.
- Special hardware applications are available.

Door Sizes and ANSI A250.8 Conversions

Steelcraft product selection for A Series Stile and Rail Doors has been matched to ANSI/SDI designations for Level and Model. Recommended minimum frame gauge also applies to the frequency of operation of the opening.

Series	ANSI A250.8 - SDI 100			Edge Construction	Edge Maximum Sizes		Recommended Gauge of Frame
	Level	Model	Description		Single	Pair	
Level 3: Extra Heavy Duty Commercial & Institutional							
A14	4	2	Seamless	Filled	4'0" x 8'0" 1219 mm x 2438 mm	8'0" x 8'0" 2438 mm x 2438 mm	14 Gauge [0.067" (1.7 mm)]

Standard glass design options

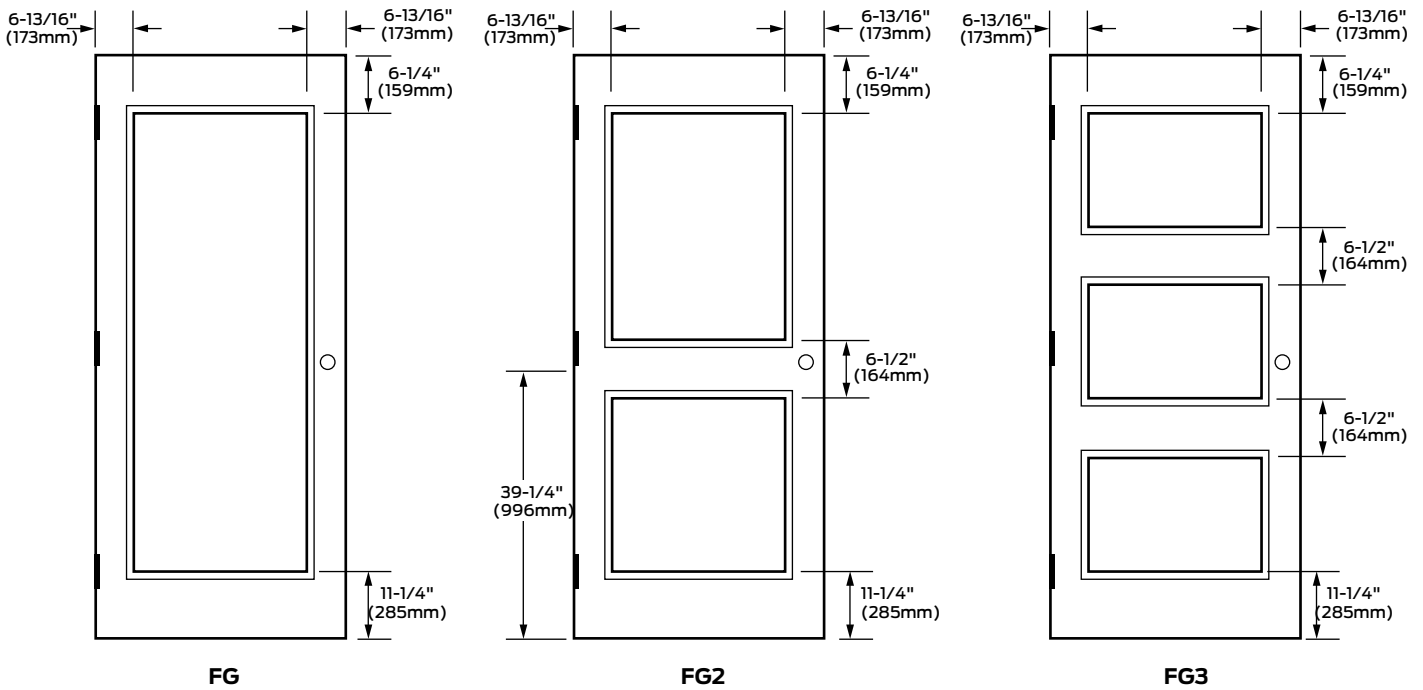

3. Dimensions shown are to the exposed glass sizes. Refer to the Lights section for cutout and glass sizes.
4. Standard Vertical Stiles (both hinge and lock) are 6 13/16" (173 mm) wide to the finished edge opening of the glass light trim (6 7/64" from the door edge to the cutout of the glass light) and are beveled 1/8" (3.2 mm) in 2" (51 mm) with no visible seams.
5. Standard Top Rails are 6 1/4" (159 mm) high and are closed with inverted 14 gauge [0.067" (1.7 mm)] welded channels. Exterior applications require the addition of top caps to protect against the weather.
6. Standard Bottom Rails are 11 1/4" (285 mm) high and are closed with inverted 14 gauge [0.067" (1.7 mm)] welded channels.
7. Standard Intermediate Rails are 6 1/2" (164 mm) high and are used to create the FG2 and FG3 designs.
8. Special glass sizes are available; however, the vertical stiles are always fixed at 6 13/16" wide regardless of the glass size.

Glass light options

(Refer to the Lights and Louvers section for further details and options – Flush Mounted Steel Trim not available on 14GA doors)

Designer® Trim

- Standard for 1/4" Thick Glass
- Optional for 1/2" Thick Glass

